

Droplet Flow Techniques for the Scalable Production of Electronic Materials



James Bannock,¹ Thomas Phillips,¹ Barnaby Walker,¹

Adrian Nightingale,¹ Siva Krishnadasan,² Martin Heeney¹ and John de Mello^{1,2}

1. Centre for Plastic Electronics, Department of Chemistry, Imperial College London, London, UK. SW7 2AZ 2. Solar Press, 2 Royal College Street, London, UK. NW1 0NH

contact: jhb06@ic.ac.uk / twp07@ic.ac.uk / j.demello@ic.ac.uk

Applications

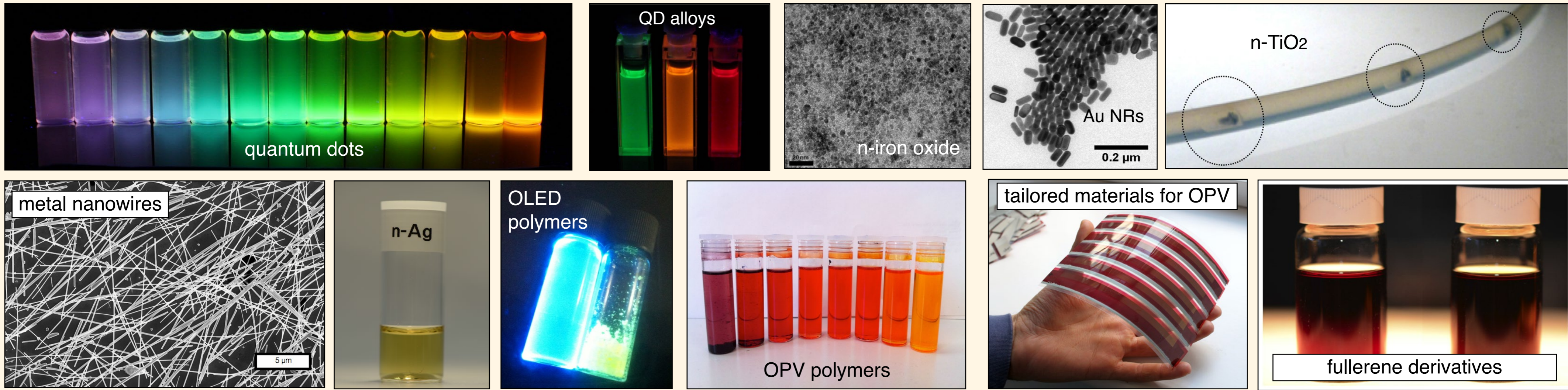

Typical Droplet Reactor

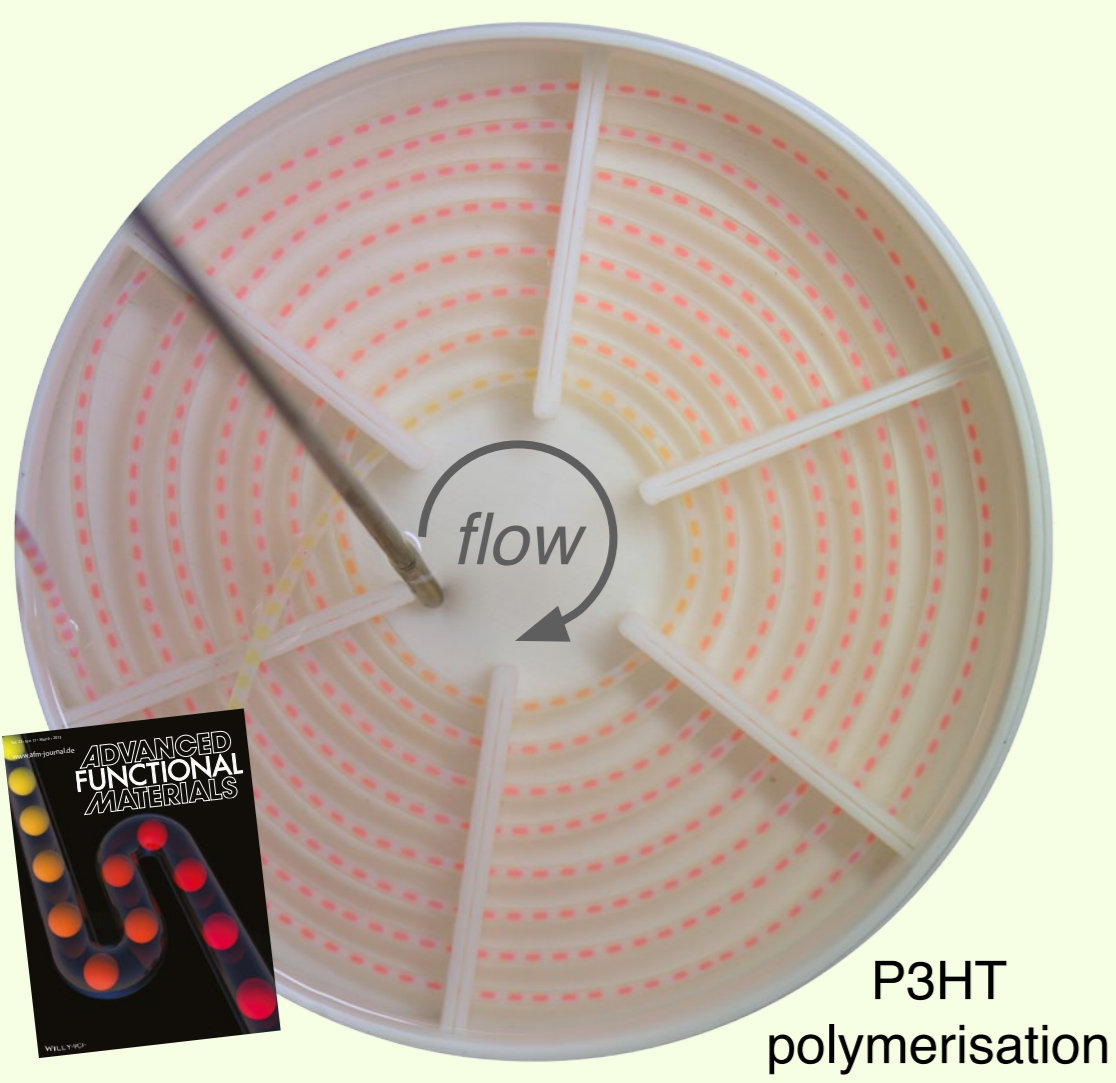

Droplet Generation

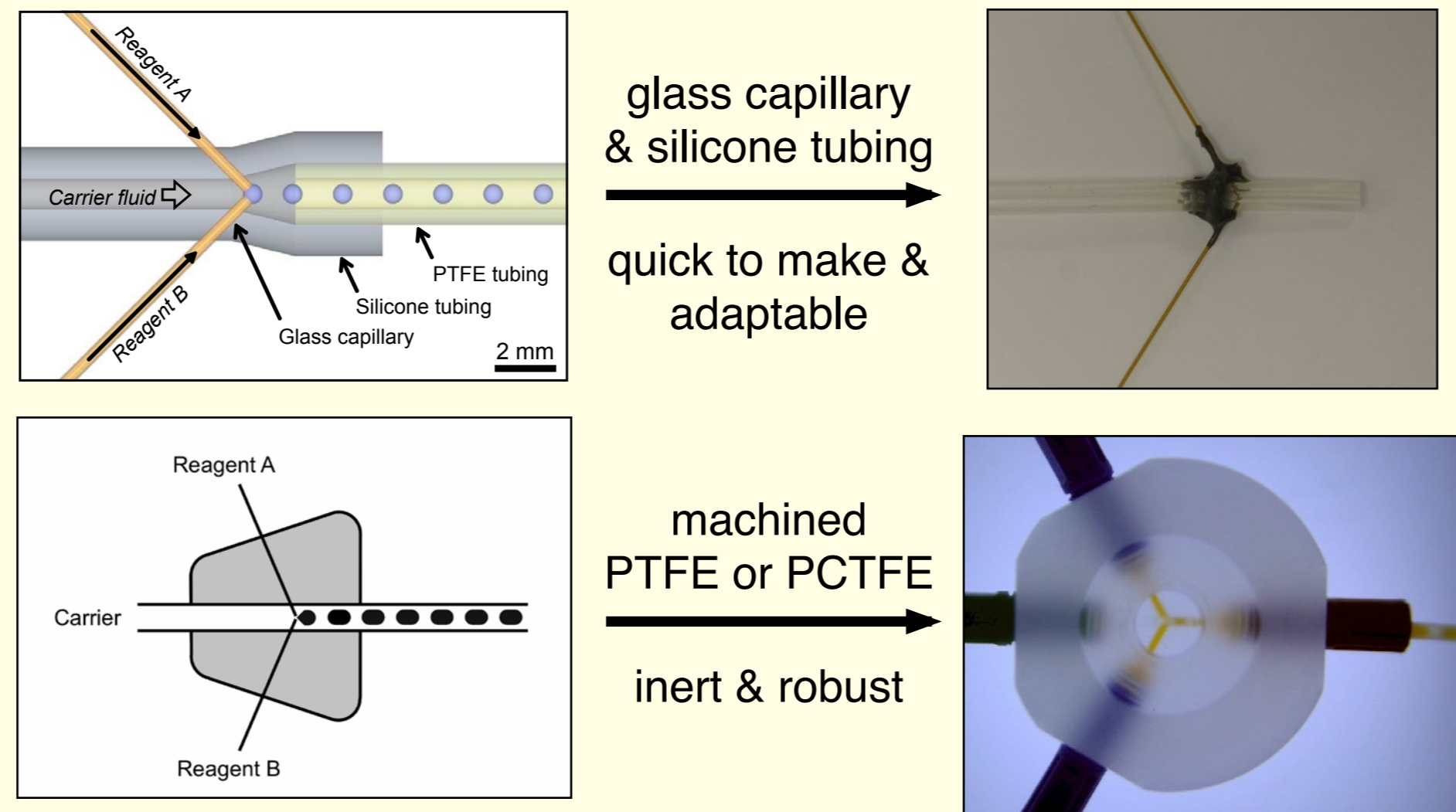

Inline Analysis

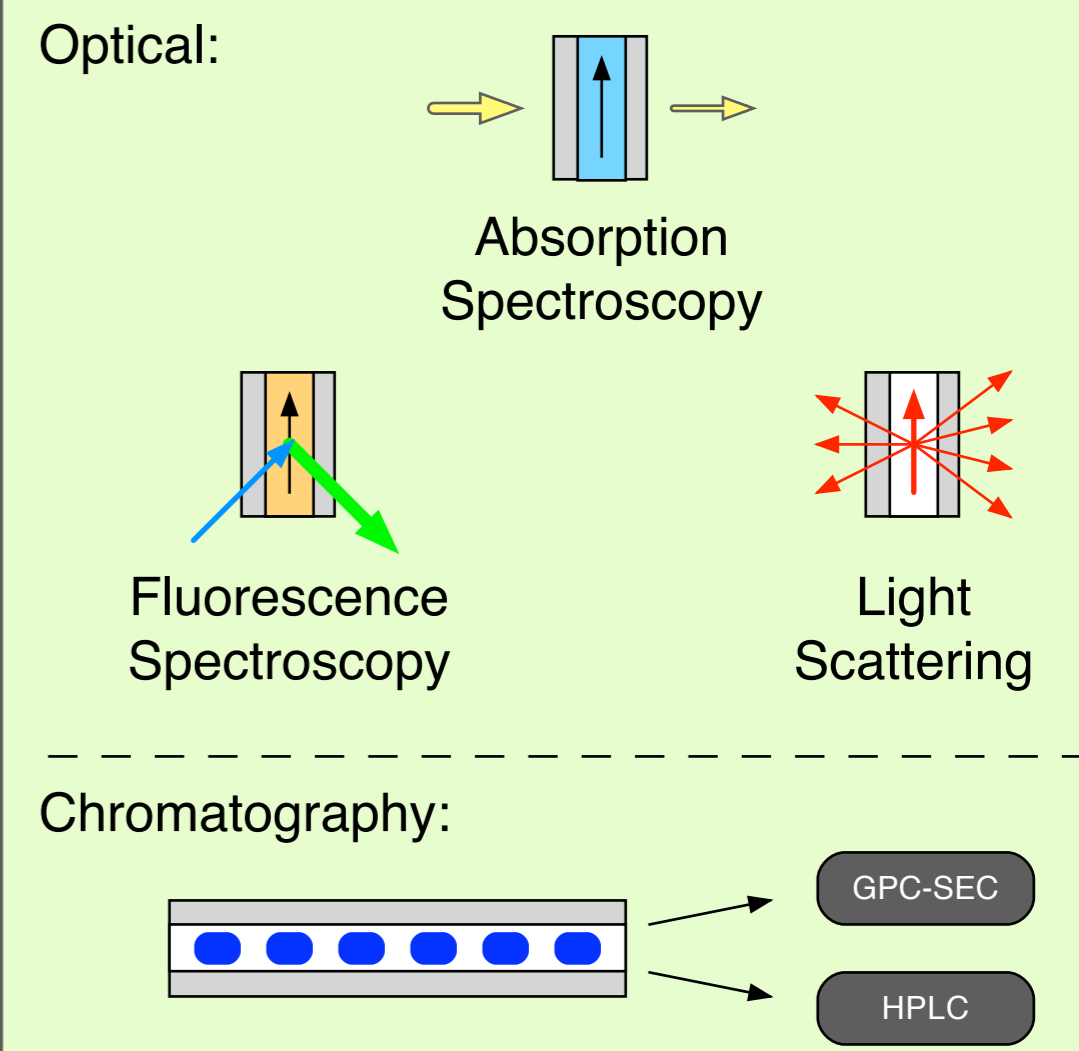

Scale-Up (QDs and Polymers)

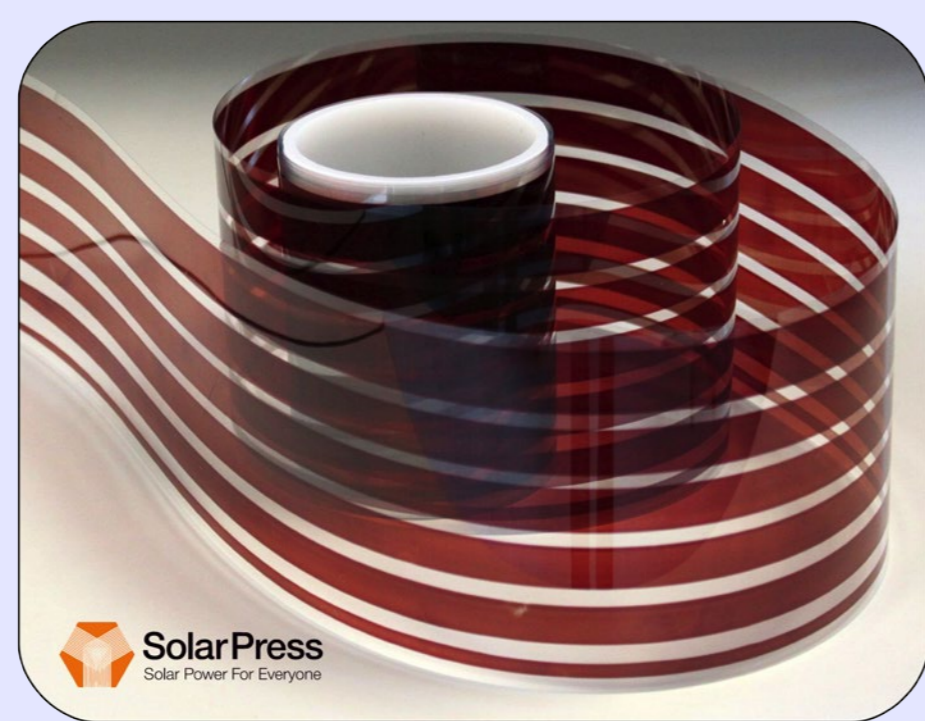
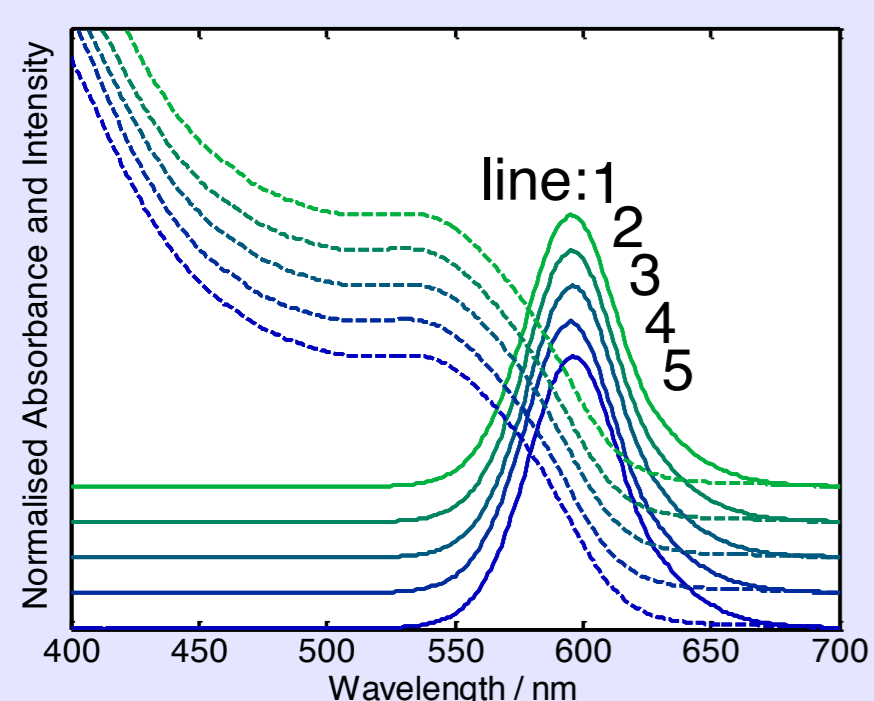
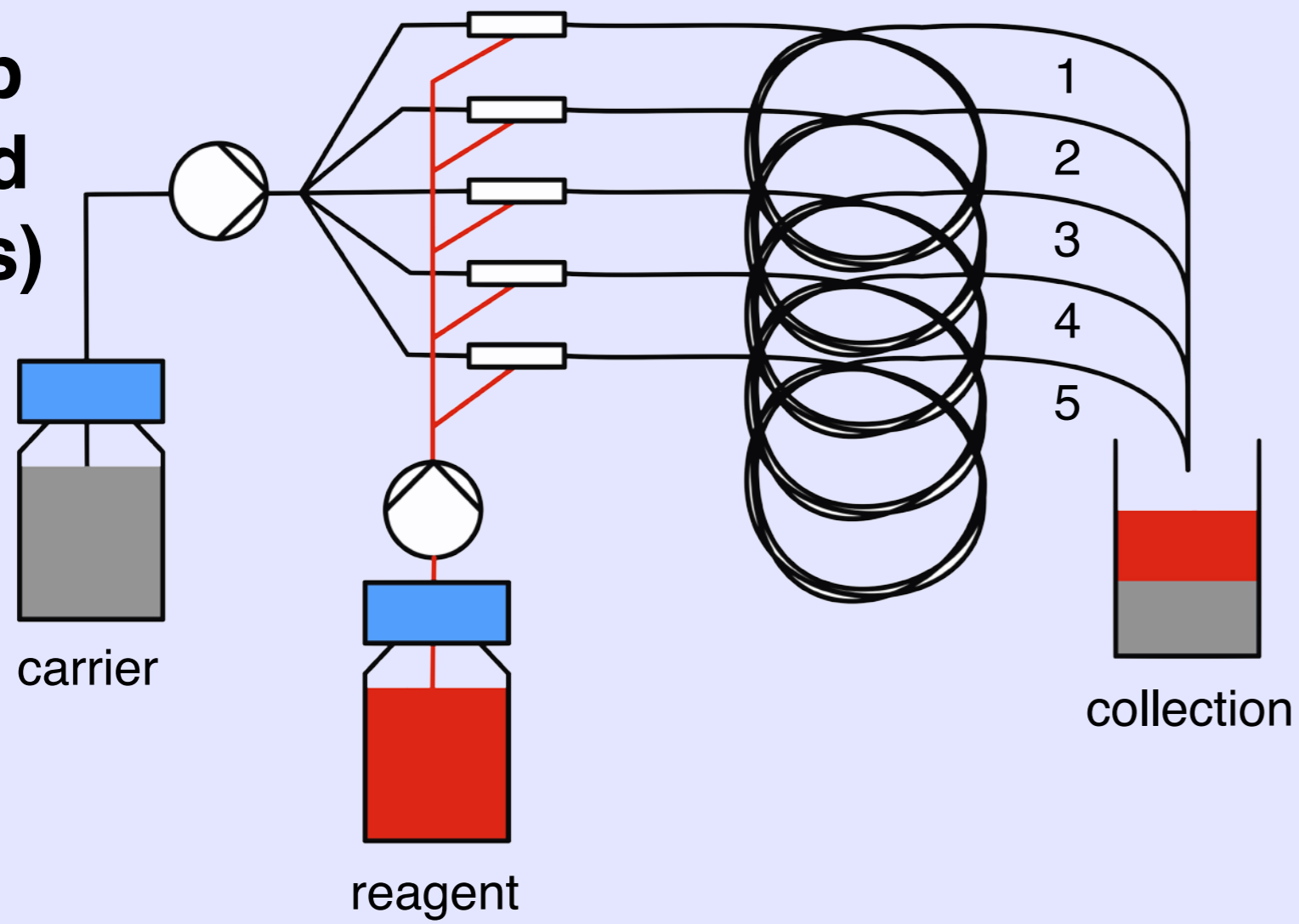

Stability

CdSe quantum dot production over 24 hrs

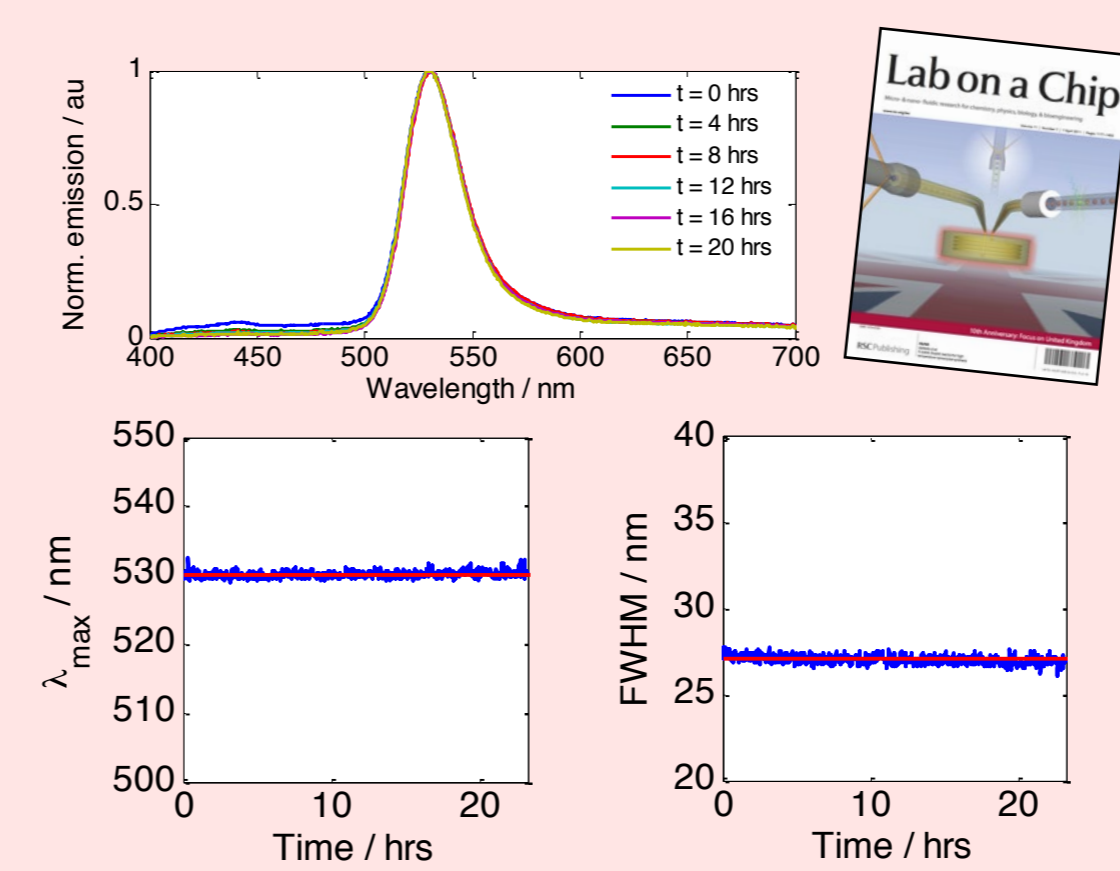

Non-fouling Advantage

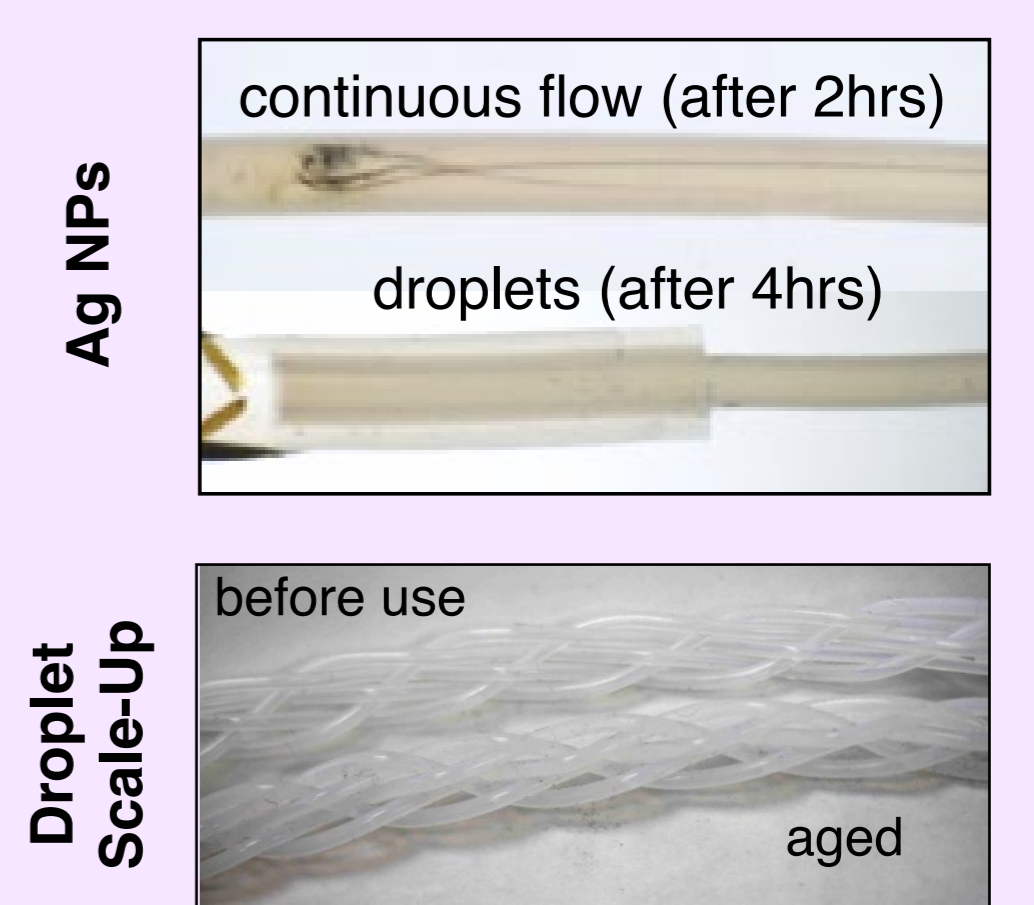

Liquid-Liquid Separators

- porous PTFE capillary

- ✓ aqueous-organic
 - ✓ aqueous-fluorous
 - ✓ fluoruous-organic
- high offset ratios
- wide operating range

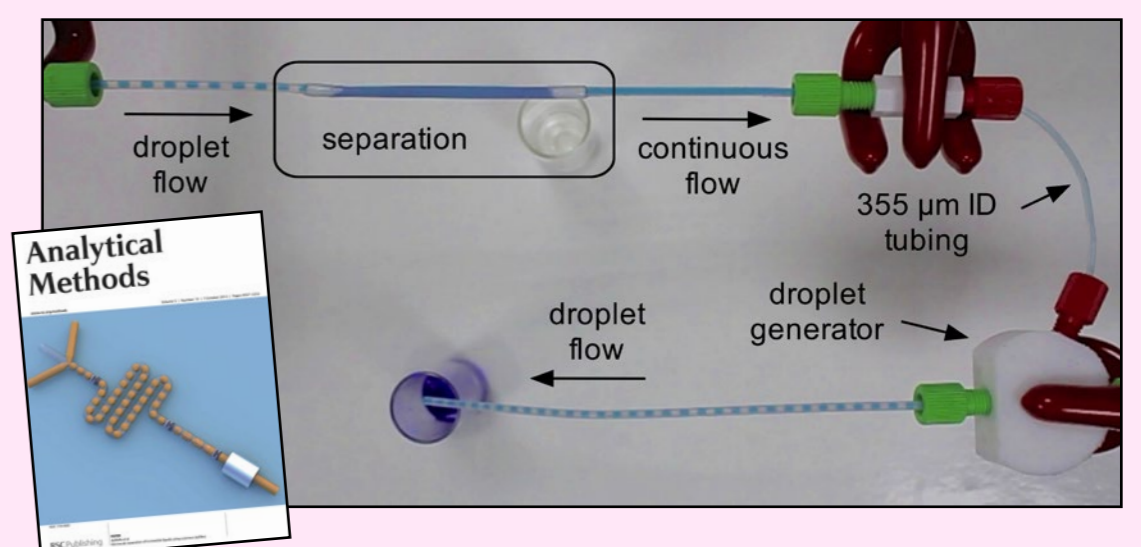
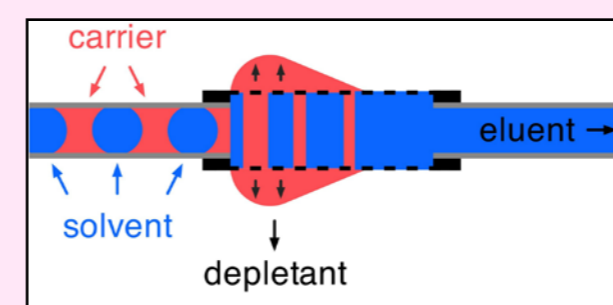

Quantum Dots

Krishnadasan *et al.*, *Lab Chip*, 2007, 7, 1434-1441; Nightingale *et al.*, *Lab Chip*, 2011, 11, 1221; Nightingale *et al.*, *J. Mater. Chem. A*, 2013, 1, 4067

Polymers

Bannock *et al.* *Adv. Funct. Mater.*, 2013, 23, 2123-2129; Bannock *et al.* *Mater. Horiz.*, 2013 (accepted)

Separator

Bannock, Phillips *et al.*, *Anal. Methods*, 2013, 5, 4991-4998